

K567

v.1

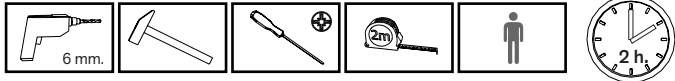

A x 06	B x 06	C x 16	D x 16	E x 16	F x 32 3.5 x 15 mm.	G x 08 3.5 x 20 mm.	H x 30	I x 12
J x 04	K x 02	L x 08	M x 01 Nº 4	N x 16 15 mm.	Ñ x 06 7 mm.			

Option A

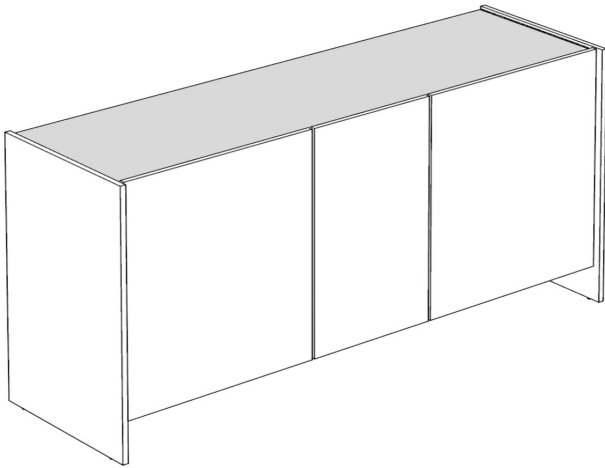

Option B

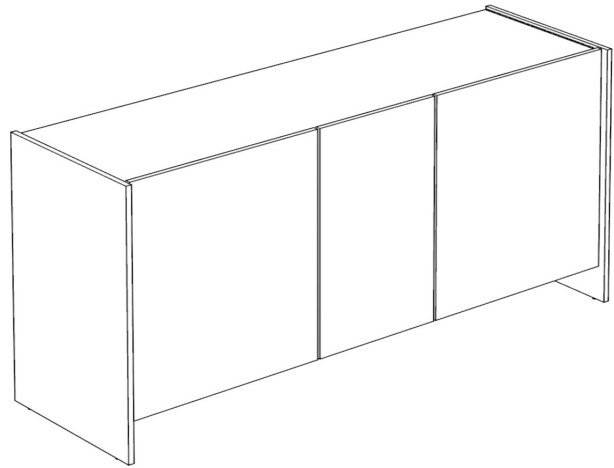

FR

CONSEILS DE MONTAGE CONSEILS POUR L'USAGE

Préparez les différents parts du meuble
Regrouper et compter toute la quincaillerie
Préparez l'outillage nécessaire
Aménagez-vous une area de montage
Faire le montage sur moquette afin de protéger le meuble des rayures
Ne forcer pas le montage
Évitez placer le meuble près des sources de chaleur
Évitez utiliser de chiffons ou des produits de nettoyage pour ne pas rayer la superficie du meuble
Meuble d'usage domestique pour l'intérieur de la maison.

PT

RECOMENDAÇÕES PARA MONTAGEM E USO

Prepare todas as peças para a montagem de móveis
Reagrupar e contar o hardware
Preparar as ferramentas de montagem
Preparar a área de montagem
Montar as peças sobre tapete para evitar riscos e danos na superfície dos móveis
Não force as assembleias
Não colocar móveis perto de fontes de calor
Evitar o uso de panos, trapos ou produtos de limpeza que possam riscar o móvel.
Móveis para uso doméstico no interior da casa.

ES

RECOMENDACIONES MONTAJE Y USO

Agrupe y cuente el herraje.
Prepare todas las piezas para el montaje del mueble.
Tenga preparadas las herramientas para el montaje.
Prepare la zona del montaje.
Monte el mueble sobre una moqueta para evitar rayar y dañar la superficie del mueble.
No fuerce los ensamblajes.
Evite colocar el mueble cerca de fuentes de calor.
Evite utilizar trapos, paños o productos de limpieza que puedan dañar la superficie del mueble.
Mueble para uso doméstico en interior de vivienda.

EN

RECOMMENDATIONS FOR ASSEMBLY AND USE

Prepare all the parts of the furniture
Group and count all the hardware
Prepare all the tools for the assembly.
Clear and prepare the assembly area.
Do the assembly on a carpet to avoid damaging the surface of the furniture
Avoid forcing the fittings
Avoid placing the Furniture near any heating source
Do not use cloths or cleaning products to avoid damaging the surface of the furniture
Indoor furniture. Suitable for domestic use.

IT

CONSIGLI INSTALLAZIONE ED USO

Preparare tutti componenti del mobile per il montaggio
Ordinare la ferramenta
Preparare tutti gli attrezzi necessari per il montaggio
Preparare l'area di montaggio
Fare il montaggio su un tappeto per evitare danneggiare le superfici dei mobili
Non forzare i componenti
Evitare posizionare il mobile in prossimità di fonti di calore
Non usare panni né detersivi né solventi che possano danneggiare le superfici dei mobili
Mobili per uso domestico all'interno della casa.

DE

MONTAGEHINWEISE-GEBRAUCHSHINWEISE

Identifizieren Sie die Einzelteile
Überprüfen Sie Die Anzahl der einzelnen Beschlagteile
Legen Sie das notwendige Werkzeug bereit
Bereiten die Montagefläche
Montieren Sie das Möbel auf einem Teppich , sauberen Untergrund
Niemals die Verbindungen zu start anziehen
Nicht neben Wärmequellen platzieren
Vermeiden Sie Tücher und keinesfalls scharfe oder ätzende Reinigungsmittel.
Möbel für den Gebrauch im Haus geeignet.

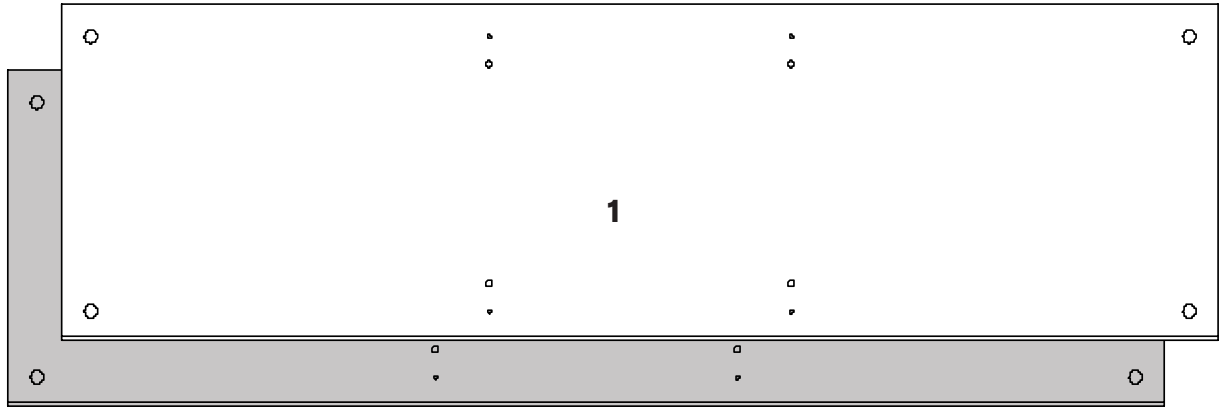

1348 x 390 mm.

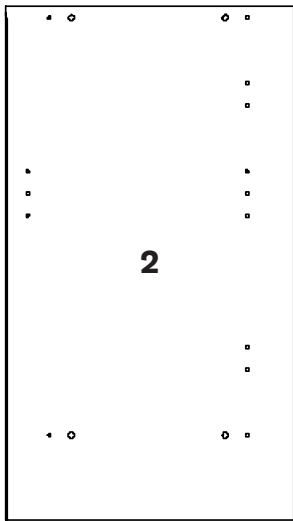

420 x 749 mm.

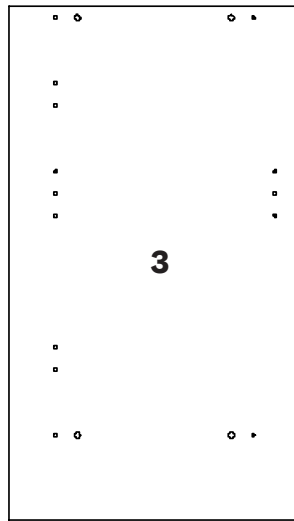

420 x 749 mm.

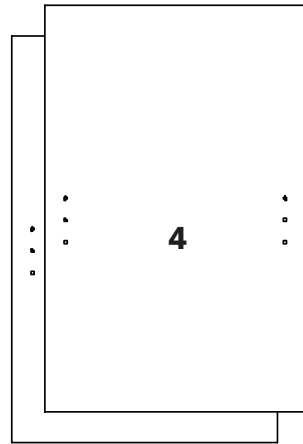

385 x 592 mm.

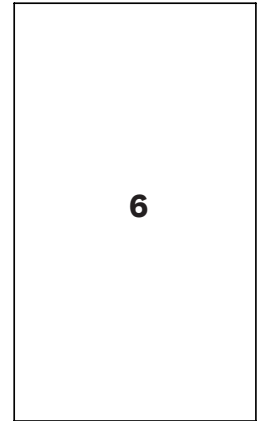

351 x 608 mm.

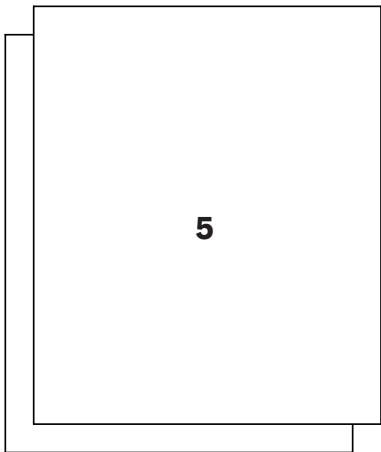

506 x 608 mm.

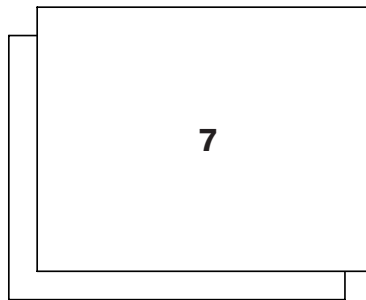

489 x 383 mm.

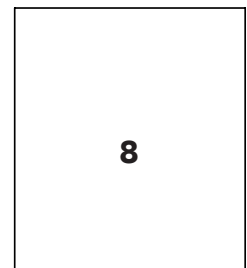

335 x 383 mm.

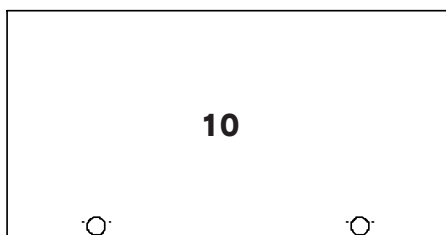

644 x 330 mm.

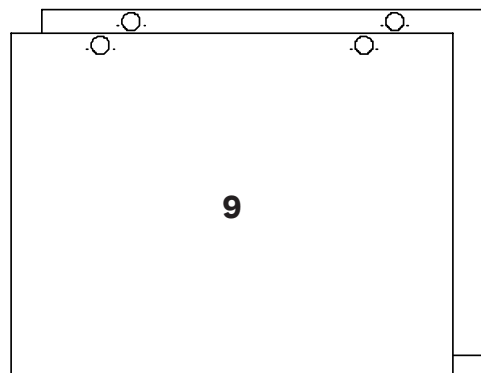

644 x 503 mm.

Option A

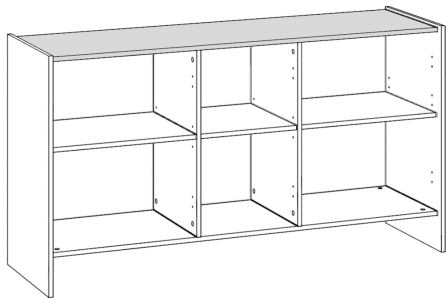

Option B

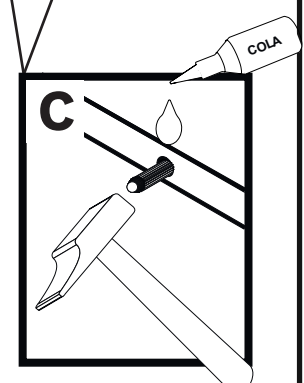
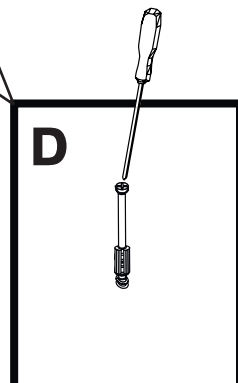
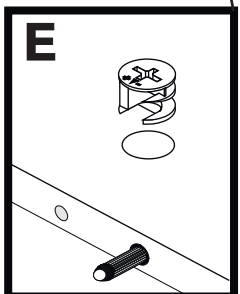
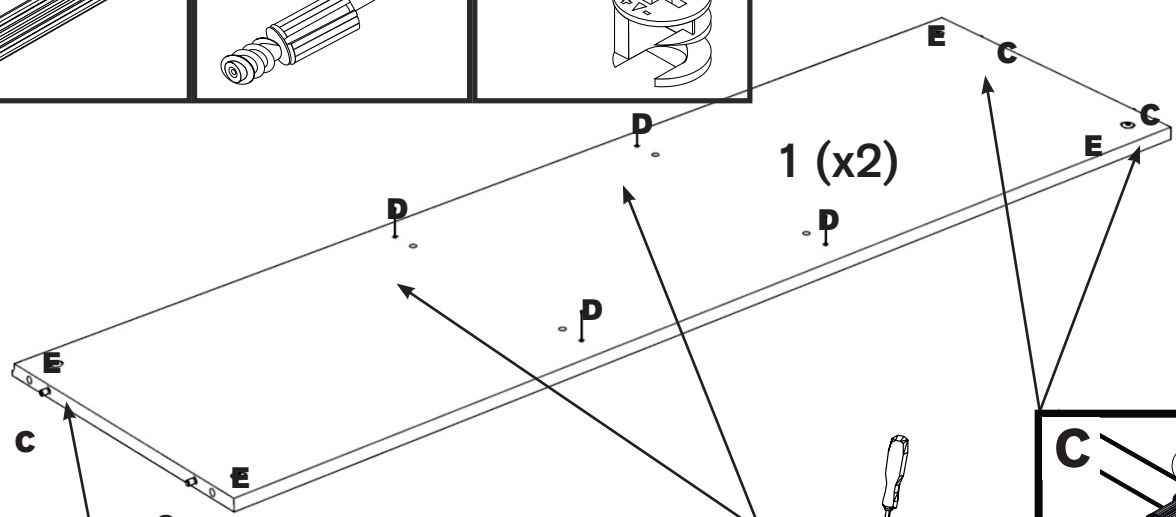
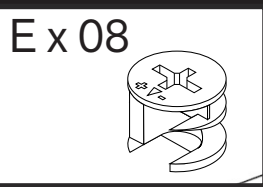
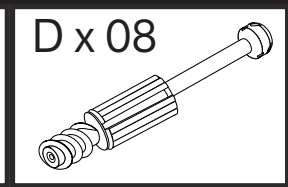
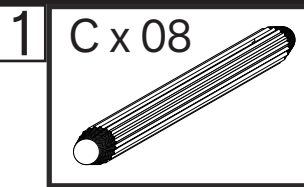
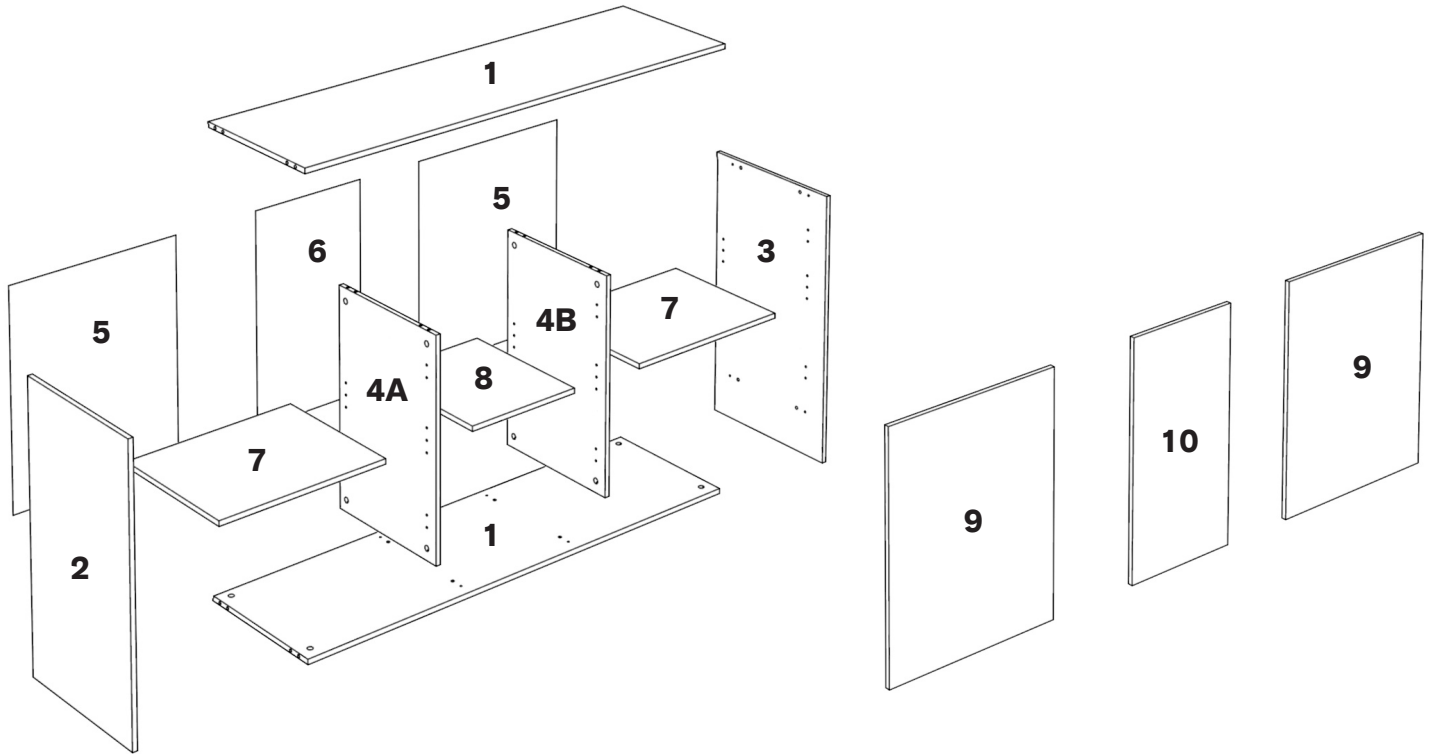
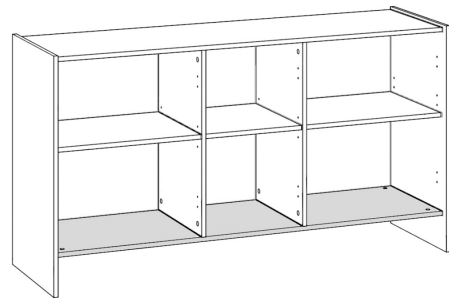

2

B x 02

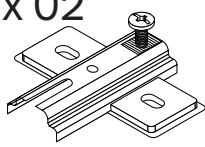

D x 04

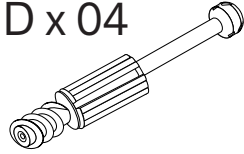

F x 04



3.5 x 15 mm.

I x 02

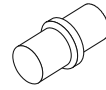

J x 02

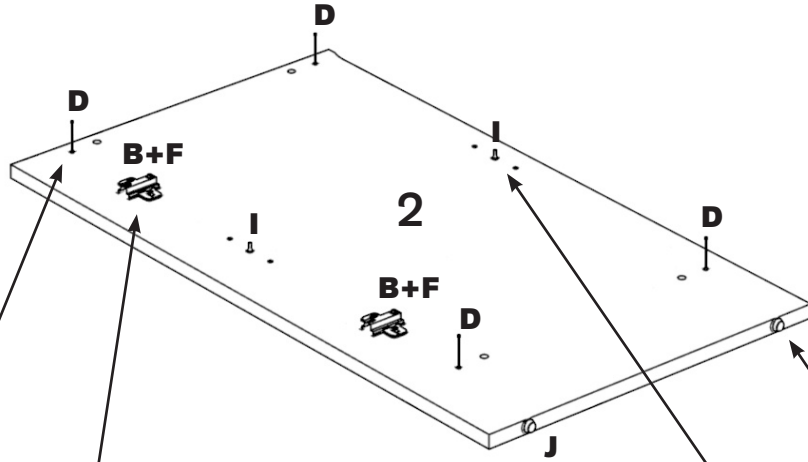
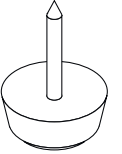

D



B+F

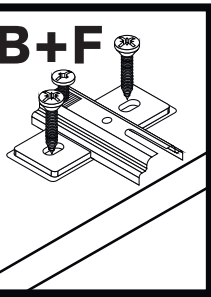

I

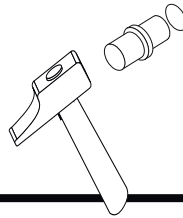

J

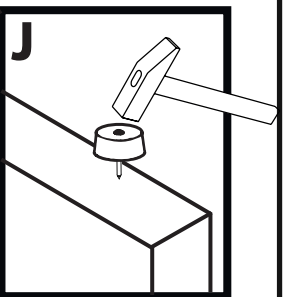

3

B x 02

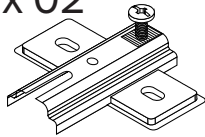

D x 04

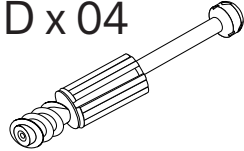

F x 04

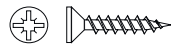

3.5 x 15 mm.

I x 02

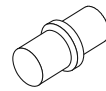

J x 02

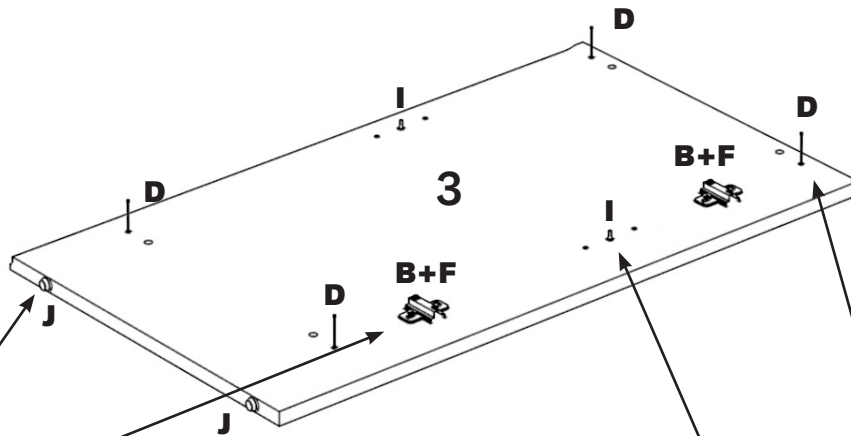
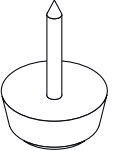

J

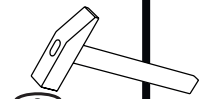

B+F

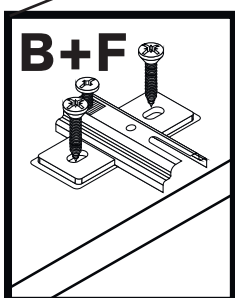

I

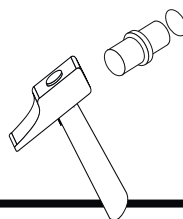

D

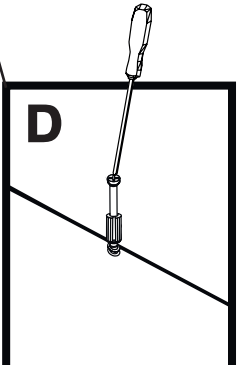

4

C x 04

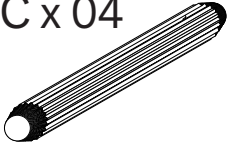

E x 04

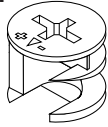

I x 04

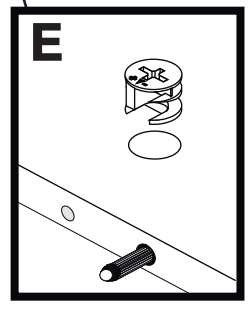
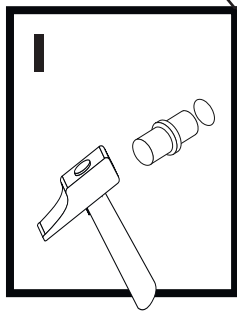
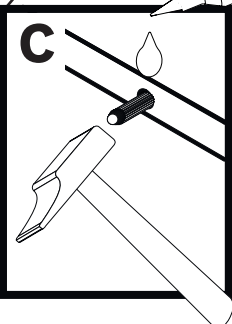
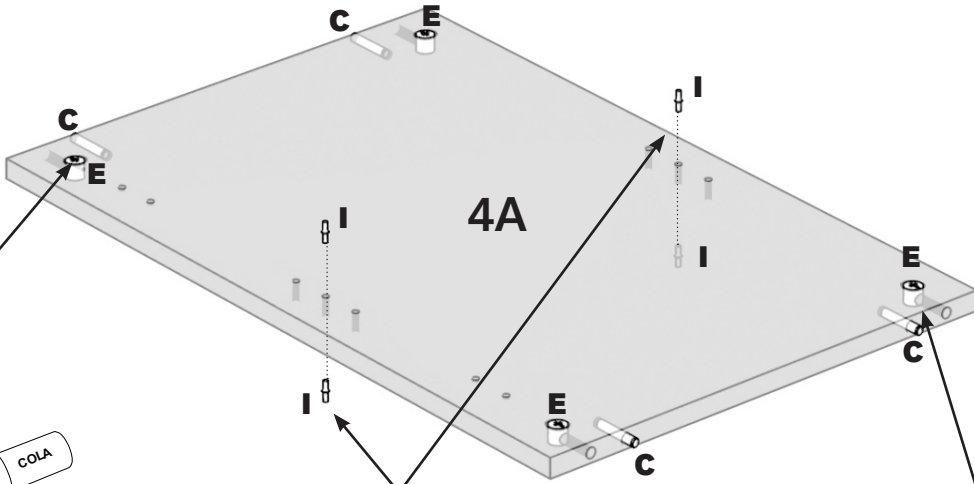
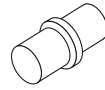

5

B x 02

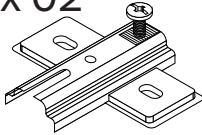

C x 04

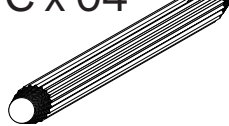

E x 04

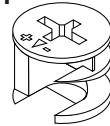

F x 04

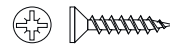

3.5 x 15 mm.

I x 04

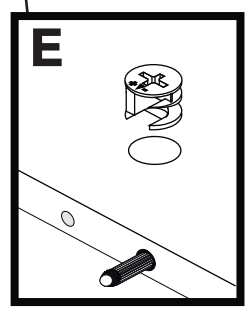
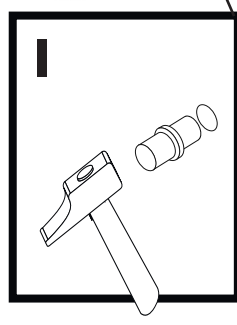
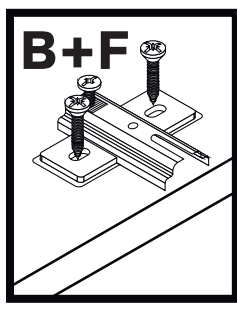
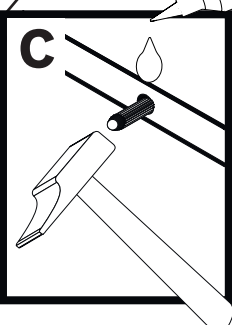
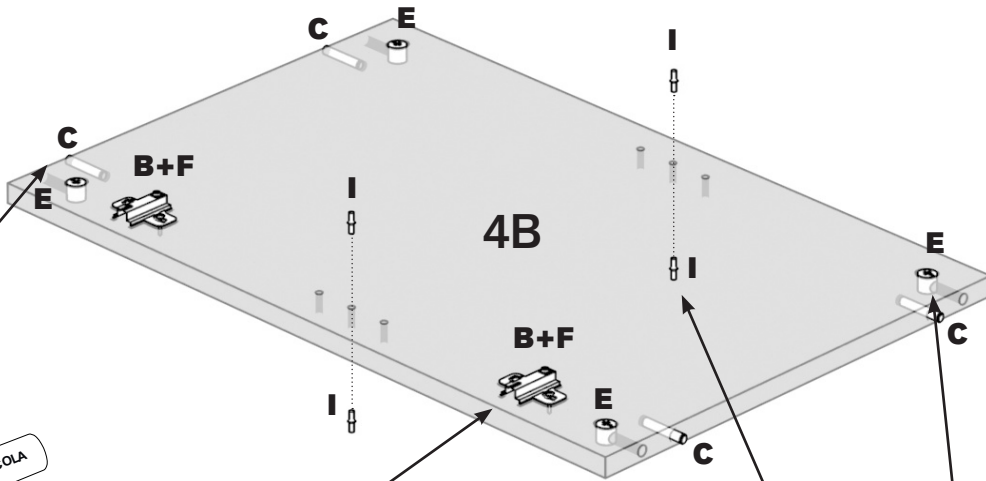
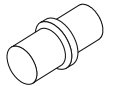

6

A x 04

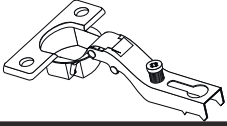

F x 08



3.5 x 15 mm.

\tilde{N} x 04



7 mm.

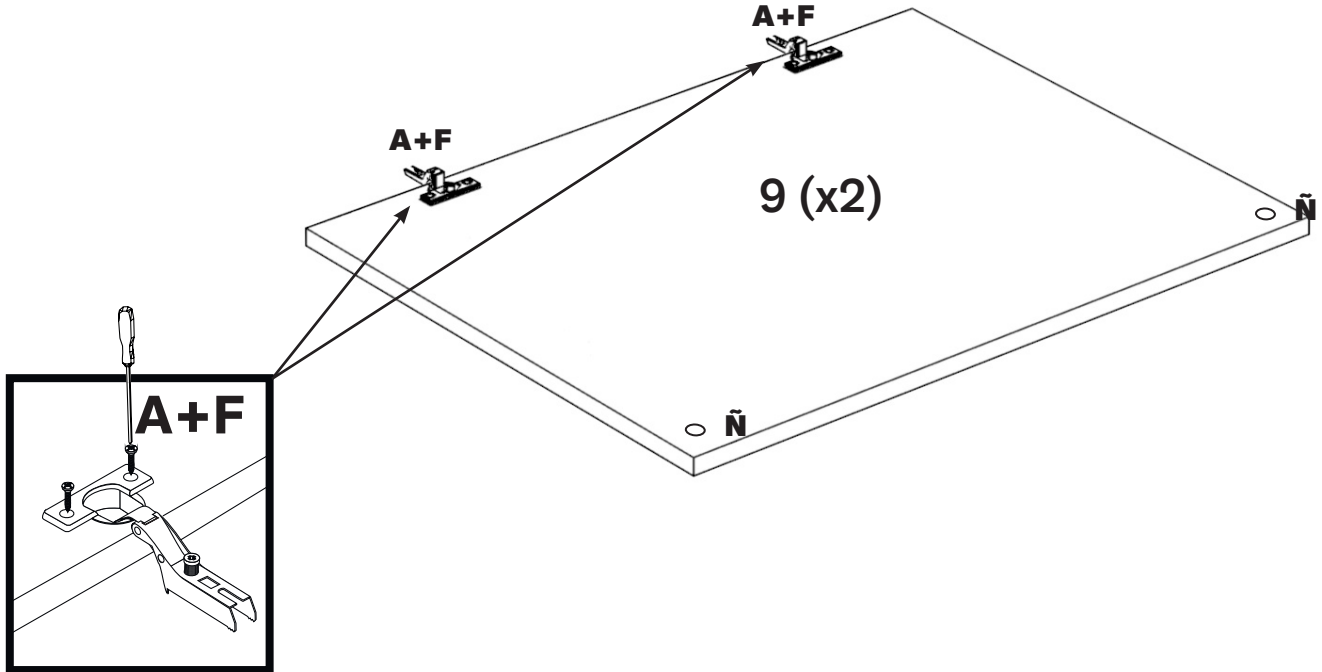

7

A x 02

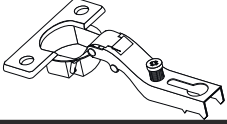

F x 04



3.5 x 15 mm.

\tilde{N} x 02



7 mm.

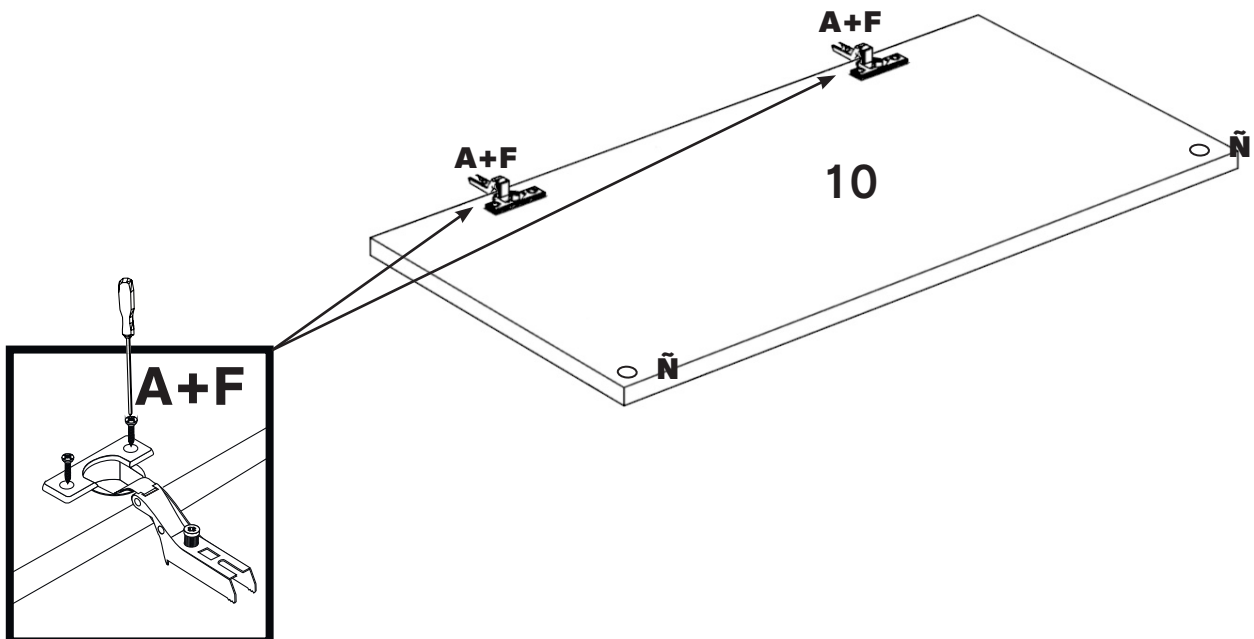

8

M x 01

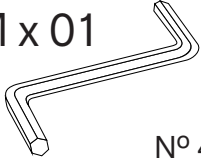

N° 4

N x 04

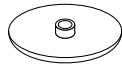

15 mm.

Option A

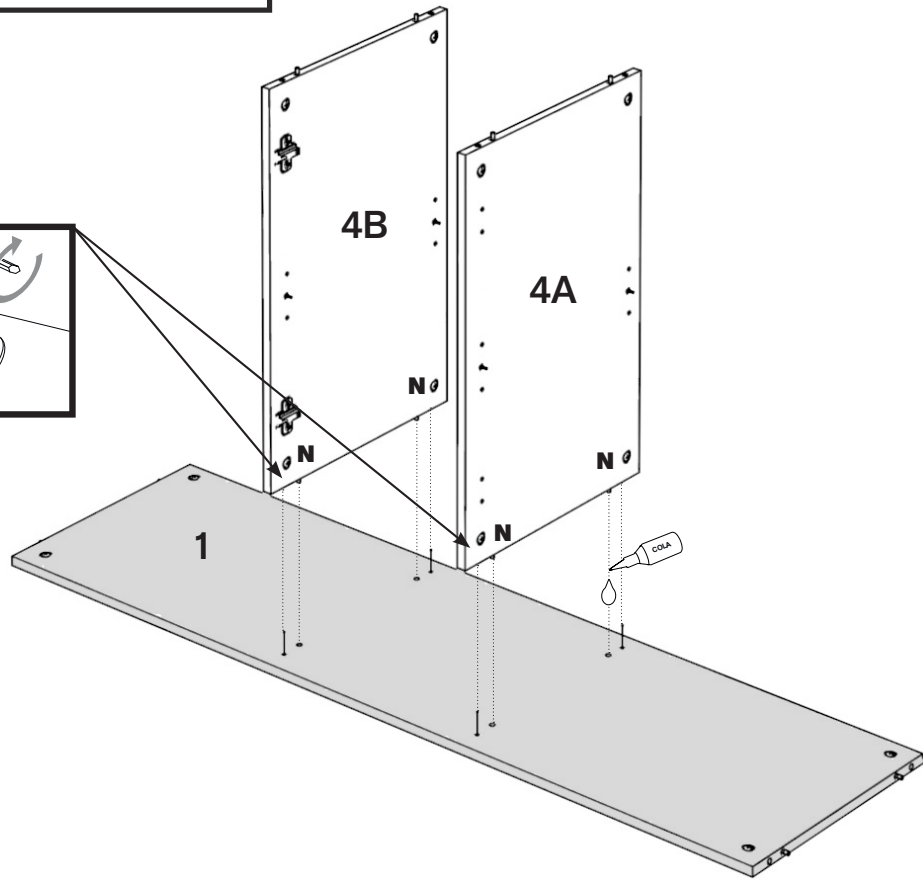
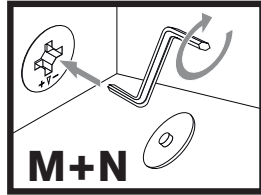

Option B

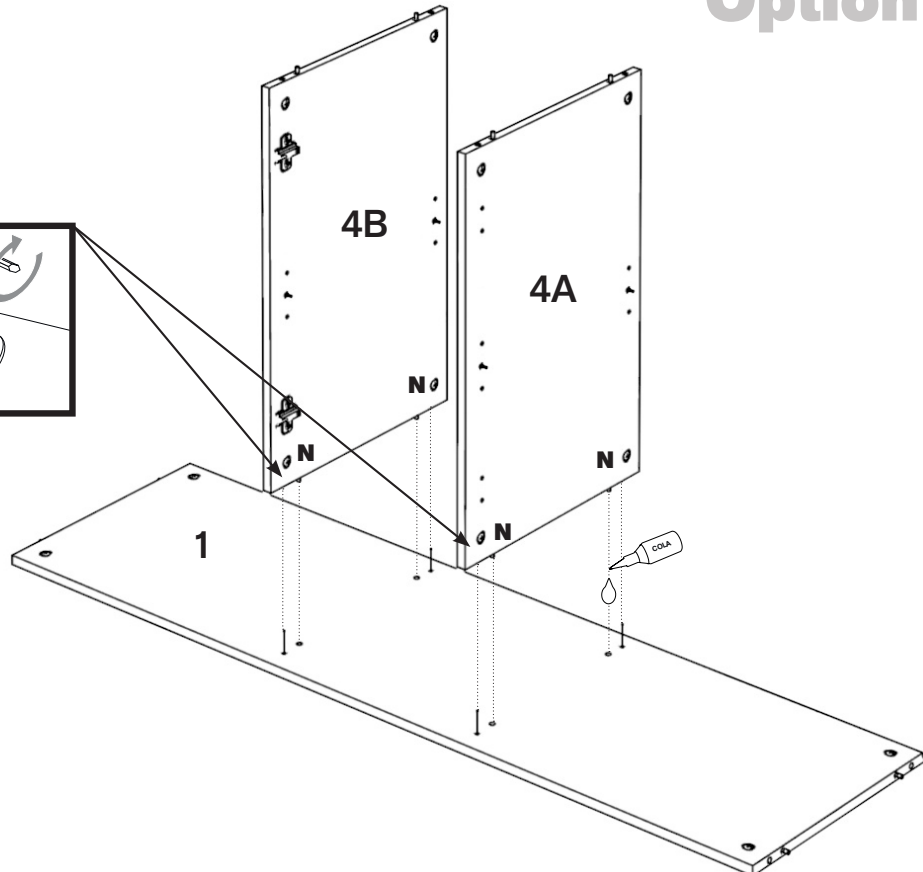
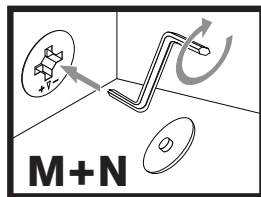

9

F x 08



3.5 x 15 mm.

K x 02

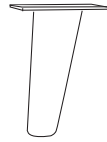

M x 01

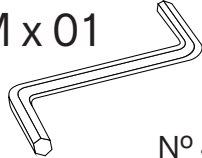

Nº 4

N x 04

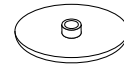

15 mm.

Option A

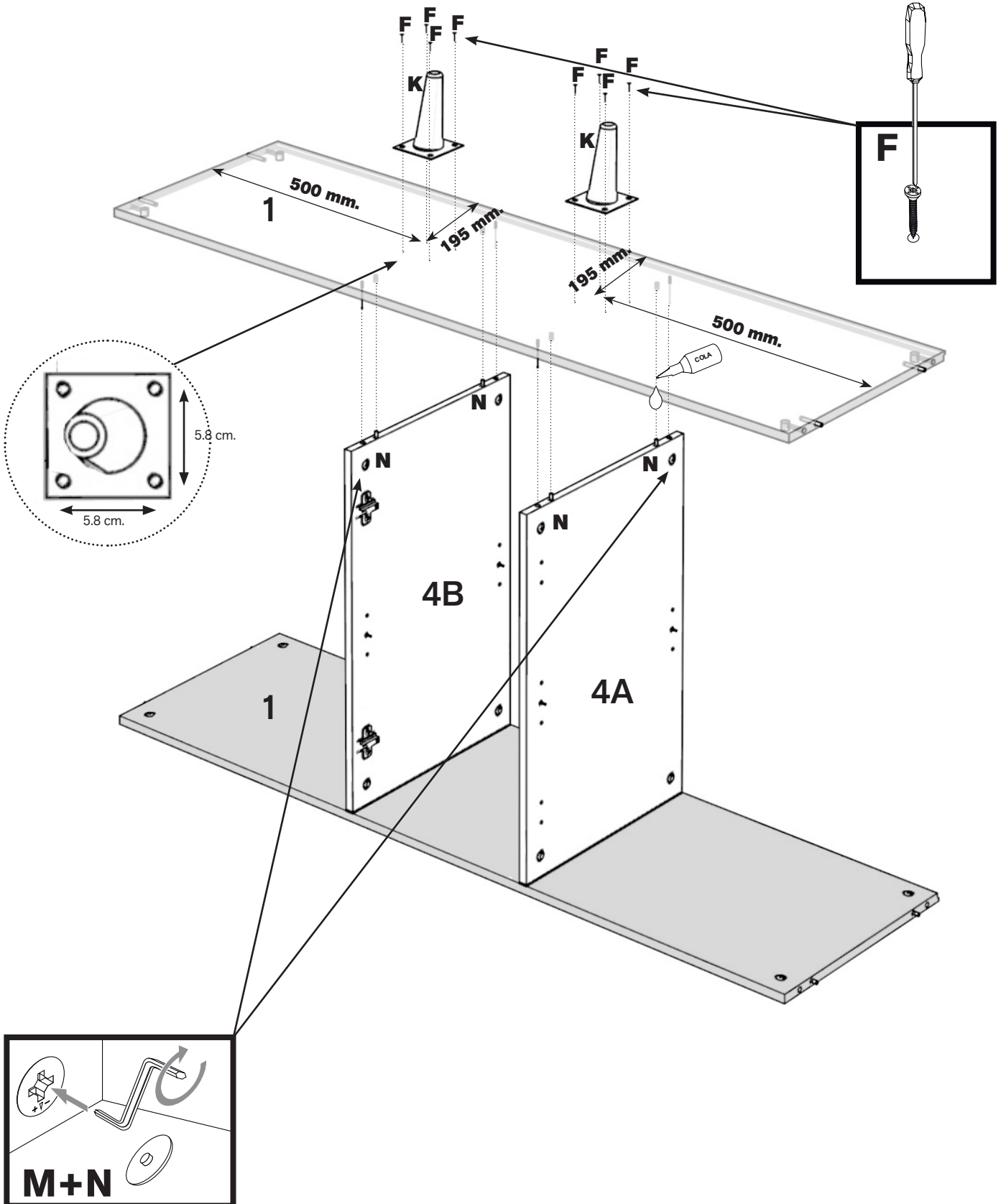

9

F x 08

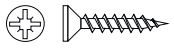

3.5 x 15 mm.

K x 02

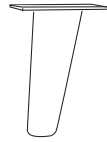

M x 01

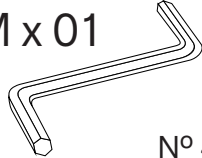

Nº 4

N x 04

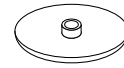

15 mm.

Option B

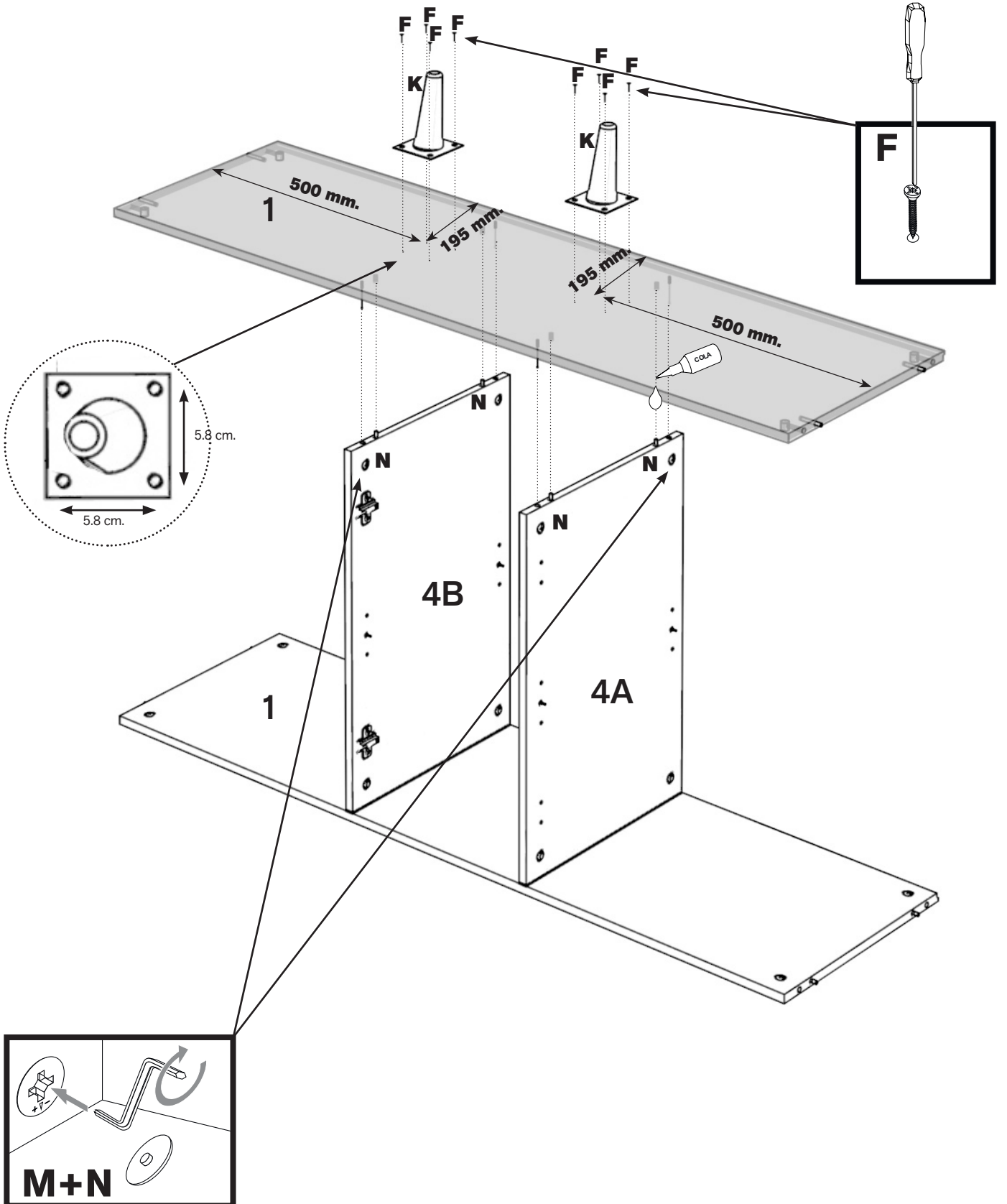

10

M x 01

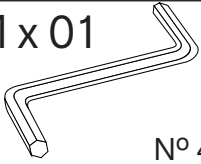

N° 4

N x 04

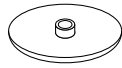

15 mm.

90°

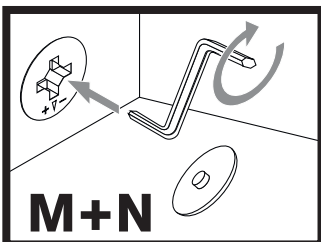
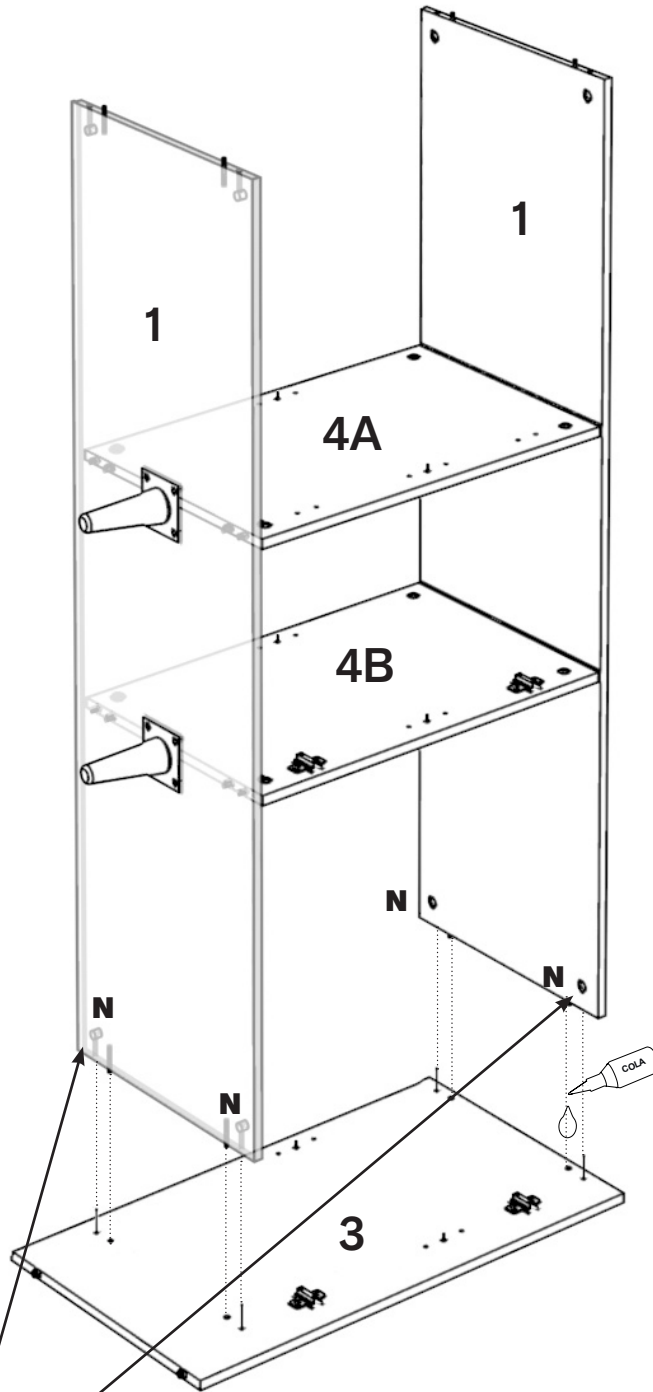
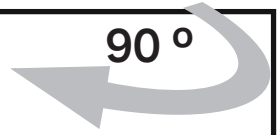

M+N

11

M x 01

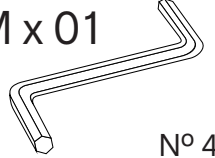

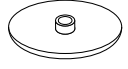

N° 4

N x 04

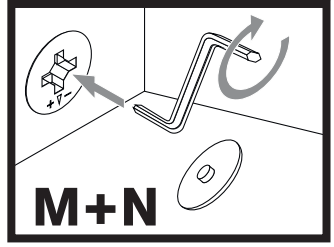
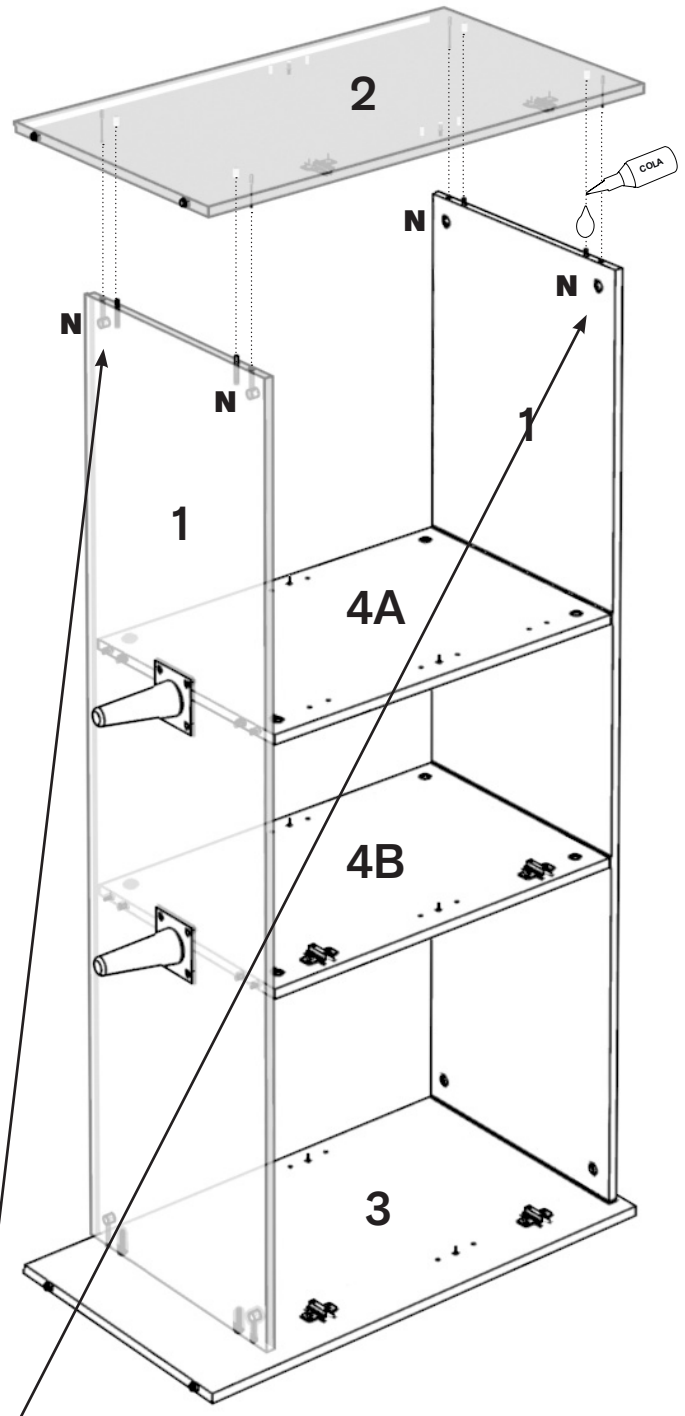

15 mm.

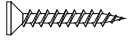
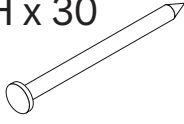
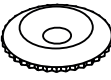

12 G x 08 H x 30 L x 08
  3.5 x 20 mm.  

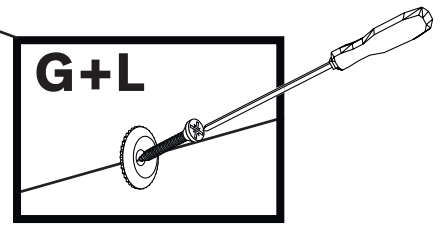
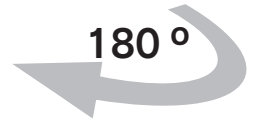
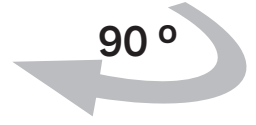
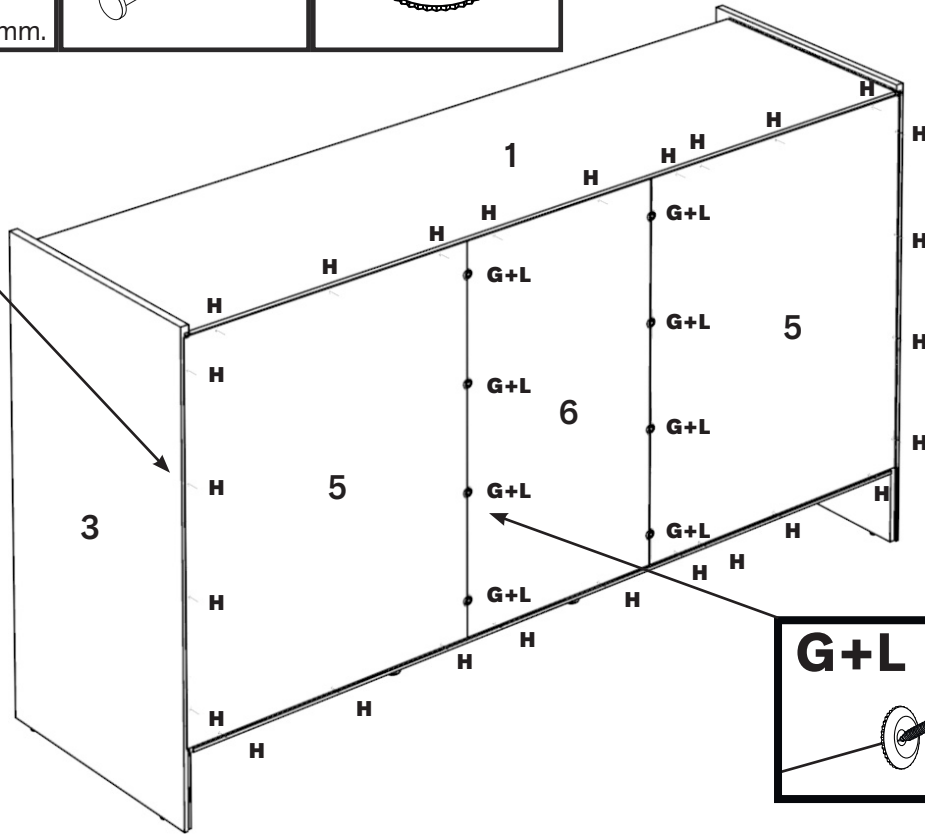
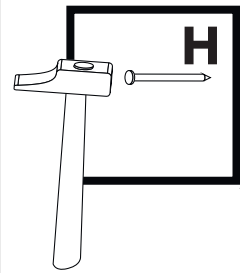

13

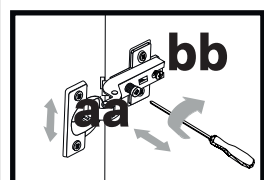
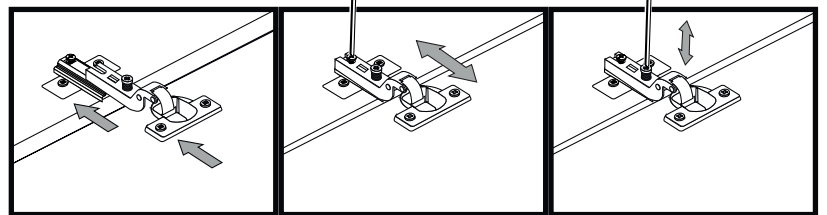
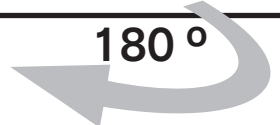
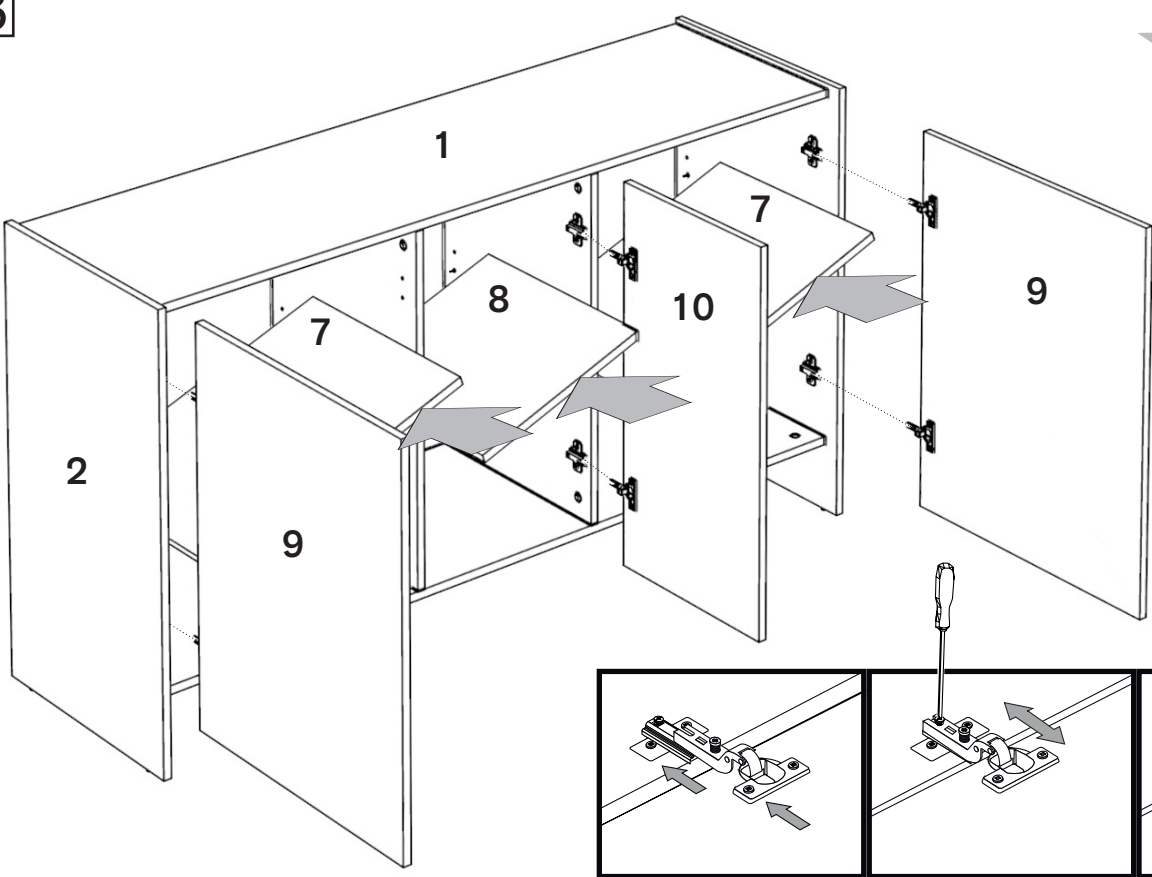

EN Before to tighten the screw "aa", you have to slacken a little the screw "bb"
ES Antes de apretar el tornillo "aa", hay que aflojar un poco el tornillo "bb"
FR Avant de presser le vis "aa", il y a que relâcher un peu le vis "bb"

PT Antes de apertar o parafuso "aa", deve desapertar um pouco o parafuso "bb"
IT Prima di serrare la vite "aa", Allentare leggermente la vite "bb"
DE Bevor die Schraube "aa" festgezogen wird lösen Sie ein wenig die schraub "bb"