

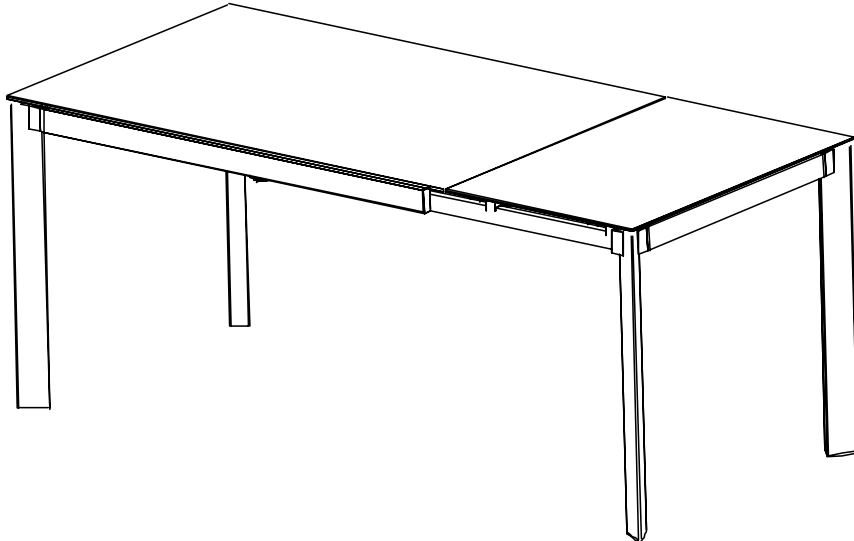

# NOTICE DE MONTAGE

NOTE OF ASSEMBLY / INSTRUCCIONES DE MONTAJE / MONTAGE-ANLEITUNG

REFERENCE NO.	148000GRIS	GRIS/GREY
REFERENCE NO.		
REFERENCIA NO. REFERENZ-NR.		
NOM DU PRODUIT		
PRODUCT NAME	AUBAGNE TABLE EXTENSIBLE ALU	
NOMBRE DEL PRODUCTO PRODUKTBEZEICHNUNG		
EAN:	3517920618323	GRIS/GREY
		



FR

1. Reperez les pieces constituant votre meuble.
  2. Regroupez et comptez la quincaillerie.
  3. Munissez vous de l'outillage necessaire.
  4. Amenez vous une zone de montage, la moquette ou une couverture protegera des rayures.
  5. procedez au montage, ne jamais forcer sur les assemblages, resserez les vis apres quelques temps d'usage.
- GARDEZ VOTRE NOTICE DE MONTAGE.**  
**SI UNE PIECE VENAIT A MANQUER ELLE SERA LE MOYEN LE PLUS CLAIR POUR COMMUNIQUER AVEC VOTRE MAGASIN.**



EN

1. Identify the parts which make up your piece of furniture.
  2. Gather the hardware parts and count them.
  3. Have the necessary tools ready.
  4. Organize a space for assembly, wall carpeting or a blanket will protect the furniture
  5. Mount the furniture, never force the parts to be assembled.
- TIGHTEN THE SCREWS AFTER IT HAS BEEN USED FOR SOME TIME.**  
**KEEP THE ASSEMBLY INSTRUCTION SINCE IT WILL HELP YOU WHEN YOU GET IN TOUCH WITH THE STORE IF A PART SHOULD BE MISSING.**



ES

1. Localice las piezas que componen su mueble.
  2. Reagrupe y cuente la tornilleria.
  3. Prepare las herramientas necesarias.
  4. Prepare una zona de montaje, la moqueta o una manta protegerá de arañazo.
  5. Proceda al montaje, no forzar sobre los embalages, apretar los tornillos después de algún tiempo de uso.
- GUARDAR LAS INSTRUCCIONES DE MONTAJE.**  
**SI UNA PIEZA LE FALTASE, SERA LA MANERA MAS FACIL DE COMUNICARSE CON SU PROVEEDOR.**



DE

1. Bitte überprüfen Sie, ob alle Einzelteile Ihres Möbelstücks vorhanden sind.
  2. Bitte überprüfen Sie, ob alle Schrauben und Verbindungsteile für die Montage vorhanden sind.
  3. Halten sie alle notwendigen Montage-Werkzeuge für ihren Einsatz gebrauchsbereit.
  4. Bereiten Sie einen passenden Ort für die Montage vor. Ein Teppichboden oder ähnliches schützt vor Kratzern.
  5. Beginnen Sie mit der Montage. Lassen Sie sich Zeit und fügen Sie die Einzelteile nie mit Gewalt zusammen.
- Um einen langfristigen und einwandfreien Gebrauch zu gewährleisten, ziehen Sie die einzelnen Schrauben regelmäßig nach längerer Nutzung des Möbelstücks fest.
- Bitte bewahren Sie diese Montageanleitung auf. Diese gewährleistet im Problemfall einen reibungslosen und schnellen Kommunikationsaustausch mit dem Kundenservice Ihres Geschäfts.

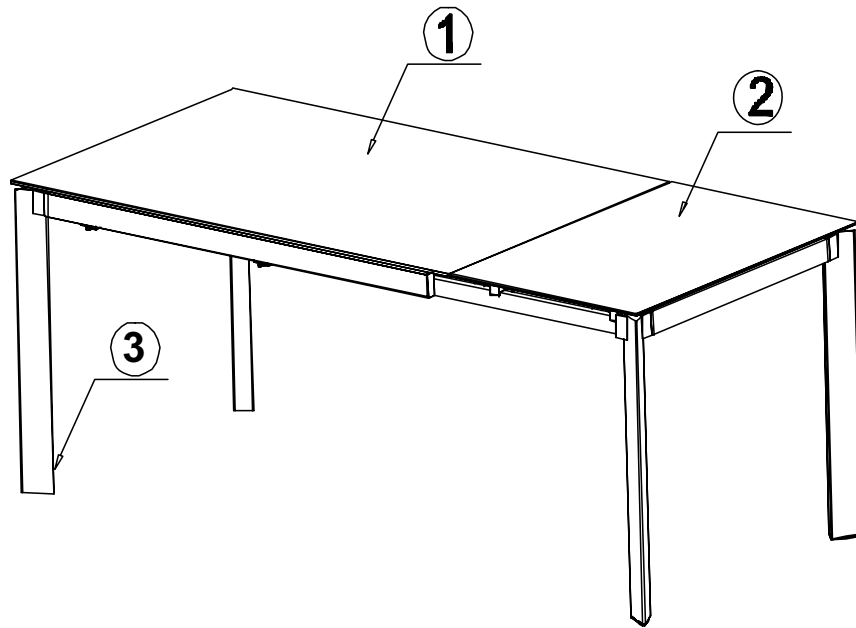

No.	Taille	Qté	Ctn no.
No.	Size	Qty	Ctn no.
No.	Tamaño	Cant	Ctn no.
Nr.	Maße	Anzahl	Ktn nr.
1	1400x900x6mm	1	1
2	900x60x6mm	1	1
3	110x90x120mm	4	1
4			
5			

No.	Taille	Qté	Ctn no.
No.	Size	Qty	Ctn no.
No.	Tamaño	Cant	Ctn no.
Nr.	Maße	Anzahl	Ktn nr.

No.	Taille	Qté	Ctn no.
No.	Size	Qty	Ctn no.
No.	Tamaño	Cant	Ctn no.
Nr.	Maße	Anzahl	Ktn nr.

**Quincailleries/Hardware/Herrajes/ Montageteile- Ctn no./Kto. nr.** 1

101 x 8

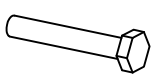

M8x35mm

102 x 8



Φ8xΦ16x1mm

103 x 8



Φ10.5x4.5mm

104 x 8



Φ17.5x17mm

105 x 1

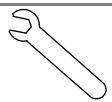

Φ26x87x2.5mm



**TEMPS DE MONTAGE: 20 MINUTE**  
**SET-UP TIME: 20 MINUTE**  
**TIEMPO DE MONTAJE: 20 MINUTO**  
**MONTAGEZEIT: 20 MINUTEN**



**OUTILLAGE:**  
**TOOLS:**  
**HERRAMIENTAS:**  
**WERKZEUGE:**



**NOMBRE DE PERSONNES: 02**  
**NUMBER OF PERSONS: 02**  
**NUMERO DE PERSONAS: 02**  
**NOTWENDIGE PERSONEN: 02**



**POUR L'ENTRETIEN, UN CHIFFON DOUX SUFFIRA.**  
**FOR GENERAL CARE, A PIECE OF CLOTH WILL BE ENOUGH.**  
**PARA EL CUIDADO GENERAL, UN PEDAZO DE PAÑO SERÁ SUFICIENTE**  
**HALTEN SIE FÜR EINE SAUBERE MONTAGE EIN FEUCHTES TUCH BEREIT.**

**SAV / Spareparts / Pos Ventas / Einzelteile** EAN 3517920618323

(No. / Nr) x (Qté/Qty/Cant/Anzahl)

101 x 8	104 x 8
102 x 8	105 x 1
103 x 8	

1

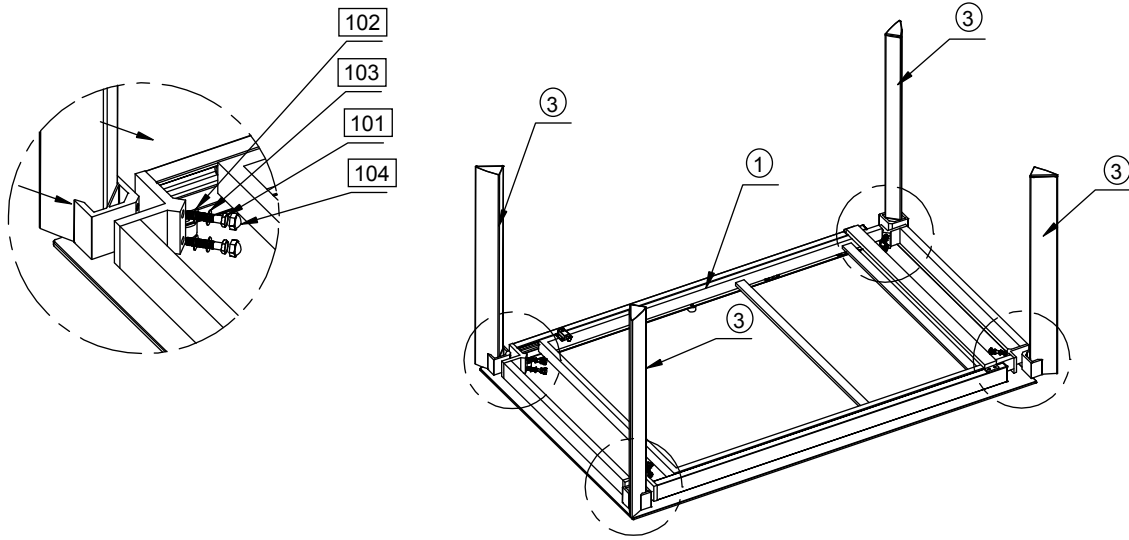

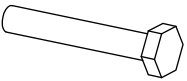
101	x 8
	
M8x35mm	

102	x 8
	
Φ8xΦ16x1mm	

103	x 8
	
Φ10.5x4.5mm	

104	x 8
	
Φ17.5x17mm	

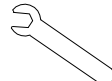
105	x 1
	
Φ26x87x2.5mm	

2

